

HEALTHCARE

COMPLETE SOLUTION FOR CLEANROOMS

Meeting the requirements of the most demanding environments

CONTENTS

THE CLEANROOM CHECKLIST	4
AIRBORNE PARTICLES: THE FEWER THE BETTER	7
HYGIENE: LEAVING GERMS NOWHERE TO HIDE	8
VOLATILE ORGANIC COMPOUNDS: MITIGATING AIRBORNE MOLECULAR CONTAMINATION	10
STATIC ELECTRICITY: CONTROLLING DISCHARGES	12
.....	
TARKETT'S COMPLETE SOLUTION OFFER	14
THE iQ RANGE	16
STATIC-DISSIPATIVE AND STATIC-CONDUCTIVE SOLUTIONS	18
HIGH PERFORMANCE WALL SOLUTIONS	20
.....	
APPENDIX: TECHNICAL DATA AND FRAUNHOFER CERTIFICATES	
iQ OPTIMA	22
iQ GRANIT	24
iQ EMINENT	26
iQ NATURAL	28
iQ GRANIT SD	30
iQ TORO SC	32
PROTECTWALL CR	34
WALLGARD	36







iQ Eminent 126

Setting new standards

The cleanroom is central to the work of today's hospitals and laboratories. It represents the most sensitive, technically demanding environment where hygiene is essential, such as in operating theatres and pharmaceutical labs. To prevent the spread of infection or the contamination of samples, pollutants like dust and airborne particles must be kept within strict limits. Cleanrooms also need durable surfaces supporting heavy load equipment that are easy to maintain, resistant to chemicals and disinfectant and able to handle static electricity.

Tarkett, a worldwide leader in innovative and sustainable flooring, is Europe's largest manufacturer of floor coverings for the healthcare sector. The company offers integrated solutions for floors and walls that meet, and often exceed, the most stringent cleanroom standards. Good to look at, simple to clean and made to last, Tarkett's specialist flooring creates spaces that are safe and pleasant for both healthcare professionals and patients.

All the floor and wall coverings in this brochure are certified as suitable for cleanrooms by the Fraunhofer Institute, Europe's largest organisation for applied research and internationally recognised as pre-eminent in its field.



THE CLEANROOM CHECKLIST

As an enclosed space where environmental factors like airflow, temperature and humidity are carefully regulated to minimise infection or contamination, the cleanroom has specific requirements.



Airborne particles

Cleanrooms are enclosed environments in which the concentration of airborne particles is specified (according to the cleanroom cleanliness) and controlled. Selecting low-emission materials is a prerequisite.



Hygiene

Sensitive spaces should be easy to clean and disinfect, as well as impervious to fluids. Smooth flooring that is suitable for coving and forms perfectly sealed joints between wall and floor will help prevent the build-up of dirt and bacteria. Flooring and walls should also be resistant to chemical and detergents as well as continuing to look like new after years of use.



Volatile Organic Compounds

Airborne molecular contamination (AMC) or chemical contamination is a concern for high-tech manufacturing processes. Phthalate free products contribute to low emissions of Volatile Organic Compounds (VOC).



Static

Static electricity can cause shocks and damage sensitive equipment in cleanrooms, presenting a hazard to patients and staff. Conductive or dissipative flooring solutions can manage static discharge.



Durability

Cleanrooms and laboratories often contain large pieces of furniture or equipment that exert a heavy load, so the flooring and walls must be strong enough to bear substantial weights without tearing, scratches or indentations.



Comfort

Cleanrooms also need floorings supporting heavy static or rolling loads. Floors with low roll-resistance make it easy to move trolleys and wheeled apparatus around.





Ambient air contains millions of pollutant particles, from dust to microbes, that can cause infection or contamination during sensitive tasks like invasive surgery and preparing medication. That's why, the demand for cleanroom technology in Healthcare is increasing. Choices of materials and surfaces in cleanrooms therefore matters, contributing to the reduction of particles.



AIRBORNE PARTICLES: THE FEWER, THE BETTER

The International Organisation for Standardisation (ISO) has established limits for the number and size of airborne particles in cleanrooms. ISO standard 14644-1 recognises nine different levels, from the least demanding (ISO 9) for low-risk environments up to the strictest (ISO 1) for areas requiring the highest protection. Most demanding cleanrooms in hospitals and pharmaceutical laboratories are usually classified as ISO 5. In the pharmaceutical industry, the classification is the European Union's Good Manufacturing Practice (EU GMP).

Classification of air cleanliness by particle concentration [ISO 14644-1]

Air cleanliness classification (particles) Maximum		Applications	Maximum concentration in number of particles per cubic metre of air ($\mu\text{m}/\text{m}^3$)					
ISO	GMP		0,1 μm	0,2 μm	0,3 μm	0,5 μm	1 μm	5 μm
ISO 1	-		10	2				
ISO 2	-		100	24	10	4		
ISO 3	-		1000	237	102	35	8	
ISO 4	-	Semi-conductor industry	10000	2370	1020	352	83	
ISO 5	A/B	Orthopedic operating rooms, Burn centers, Immunotherapy, Aseptic manufacturing	100000	23700	10200	3520	832	29
ISO 6	C	Operating rooms, Pharmaceutical product manufacturing	1000000	237000	102000	35200	8320	293
ISO 7	D					352000	83200	2930
ISO 8	-	Food processing, packing				3520000	832000	29300
ISO 9	-					35200000	832000	293000



Our flooring and wall coverings meet the requirements of **ISO 5** cleanrooms commonly specified in the most demanding healthcare environments.



HYGIENE: LEAVING GERMS NOWHERE TO HIDE

The germs that cause infection or contamination can gather anywhere, from skirtings and ledges to walls and floors. Cleanrooms should avoid recesses or awkward angles that are difficult to sanitise and disinfect. Surfaces must be accessible, smooth and watertight with good resistance to chemicals.

**Tarkett's accessories
for the CleanRoom are developed
to allow perfect cleaning
of corners and skirtings.**

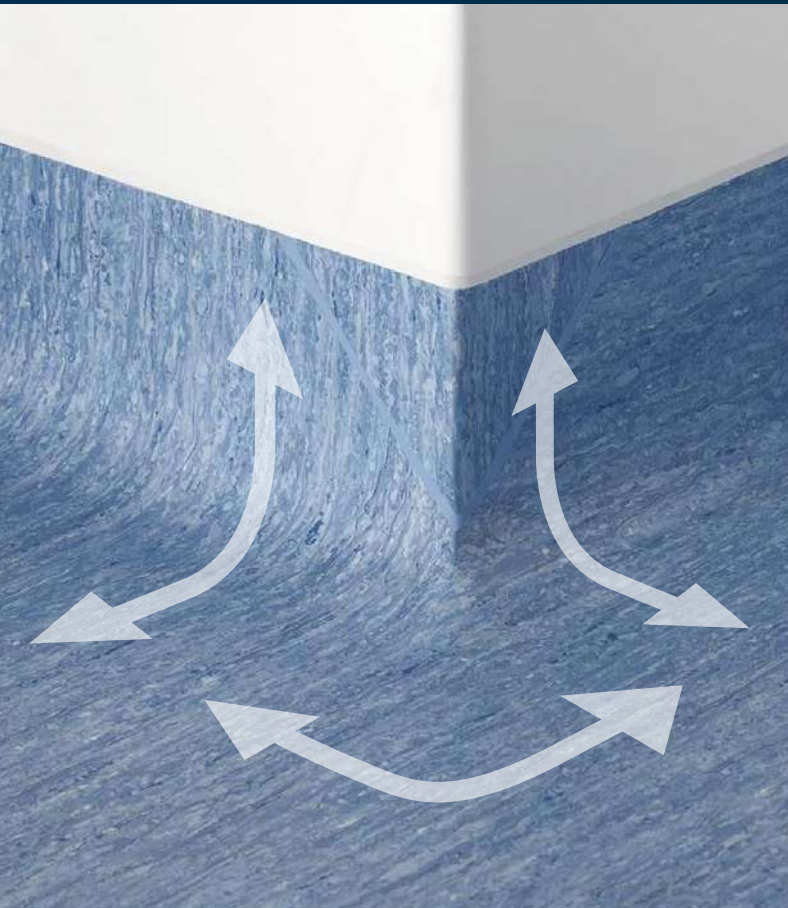

**Our preformed seamless internal
coves make vinyl installation
in corners as simple and hygienic
as possible.**

Tarkett flooring and wall coverings provide superior performance and are especially effective in the demanding cleanroom environment, discouraging bacterial development, simplifying cleaning and providing excellent stain and chemical resistance. Coving and perfectly sealed joints eliminate traps for dirt or dust while offering a watertight finish and enhanced seam strength.

Chemical resistance

ISO 26987

Excellent*

		AFTER 2H EXPOSURE			
		iQ ranges	Heterogeneous vinyl		
			ProtectWALL CR	WallGard	
Acid	Acetic acid CH ₃ COOH	80%	0	0	0
	Hydrochloric acid HCl	37%	0	0	0
	Phosphoric acid H ₃ PO ₄	38%	0	0	0
	Nitric acid HNO ₃	30%	0	0	0
	Sulfuric acid H ₂ SO ₄	30%	0	0	0
Organic Solvents	Acetone C ₃ H ₆ O	>98%	0	0	0
	Ethanol C ₂ H ₅ OH	>98%	0	0	0
	Isopropanol C ₃ H ₈ O	>98%	0	0	0
	Formaldehyde CH ₂ O	37%	0	0	0
Alkali	Ammonia NH ₄ OH	25%	0	0	0
	Sodium hydroxide NaOH	50%	0	2	0
Antiseptics & disinfectants	Eosin		1	3	3
	Iodine	1% (alcohol)	3	3	3
	PVP-I (Povidone-iodine) - Betadine yellow bottle		0	2	2
	PVP-AI - Alcoholic Betadine Orange bottle		1	3	2
	PVP-I Scrub - Betadine Red bottle		0	3	2
	Chlorhexidine gluconate 0.5%		0	0	0
	Chlx gluconate-Alcohol(Hibitane Plus)		0	0	0
	Hydrogen peroxide	30%	0	0	0
	Peracetic acid C ₂ H ₄ O ₃	15%	0	0	0
	Quaternary Ammonium (used in Floor cleaners)	30%	0	0	0
Sodium hypochlorite (Bleach)	0.5% active chloride	0	0	0	

The test is based on the NF EN ISO 26987 norm.

0 > Not affected 1 > Slightly affected 2 > Moderately affected 3 > Intensely affected

Bacteria resistance

ISO 846

Does not favor bacterial growth (Pseudomonas aeruginosa).





VOLATILE ORGANIC COMPOUNDS: MITIGATING AIRBORNE MOLECULAR CONTAMINATION

Airborne Molecular Contamination (AMC) is chemical contamination in the form of vapors or aerosols that can have detrimental effect on a product or a process especially in the high tech industry. Materials can be a source of AMR (antimicrobial resistance).



ISO 16000-6 defines how to analyse total volatile organic compounds (TVOCs) emitted by materials capable of degrading indoor air quality.



ISO 14644-8 classifies airborne molecular contamination (AMC) in terms of the atmospheric concentration of specific chemical substances in cleanroom air. This applies to products and processes that are sensitive to airborne contamination, such as in the healthcare, pharmaceutical and microelectronic sectors.

* Phthalate-free: research studies suggest that phthalates could have a noxious effect on human health by affecting human reproduction and development, and by increasing the sensitivity of those suffering from asthma and allergies. This is why at Tarkett we have reviewed the composition of our products, ensuring they are all phthalate-free.

TVOC emission levels:

10 μ g/m³

(after 28 days)

according to ISO 16000-6

ISO-AMC

Class - 9.6

(at 23°C)

according to ISO 14644-8



iQ Granit 160



iQ Eminent 888



STATIC ELECTRICITY: MANAGING DISCHARGE

Static electricity is generated by friction, such as from clothing or by shoes rubbing on the floor. Discharges may be painful, but they can also damage sensitive equipment typically found in operating theatres, radiology rooms and pharmaceutical laboratories. This makes reducing the risk of electrostatic discharge a priority in cleanrooms.



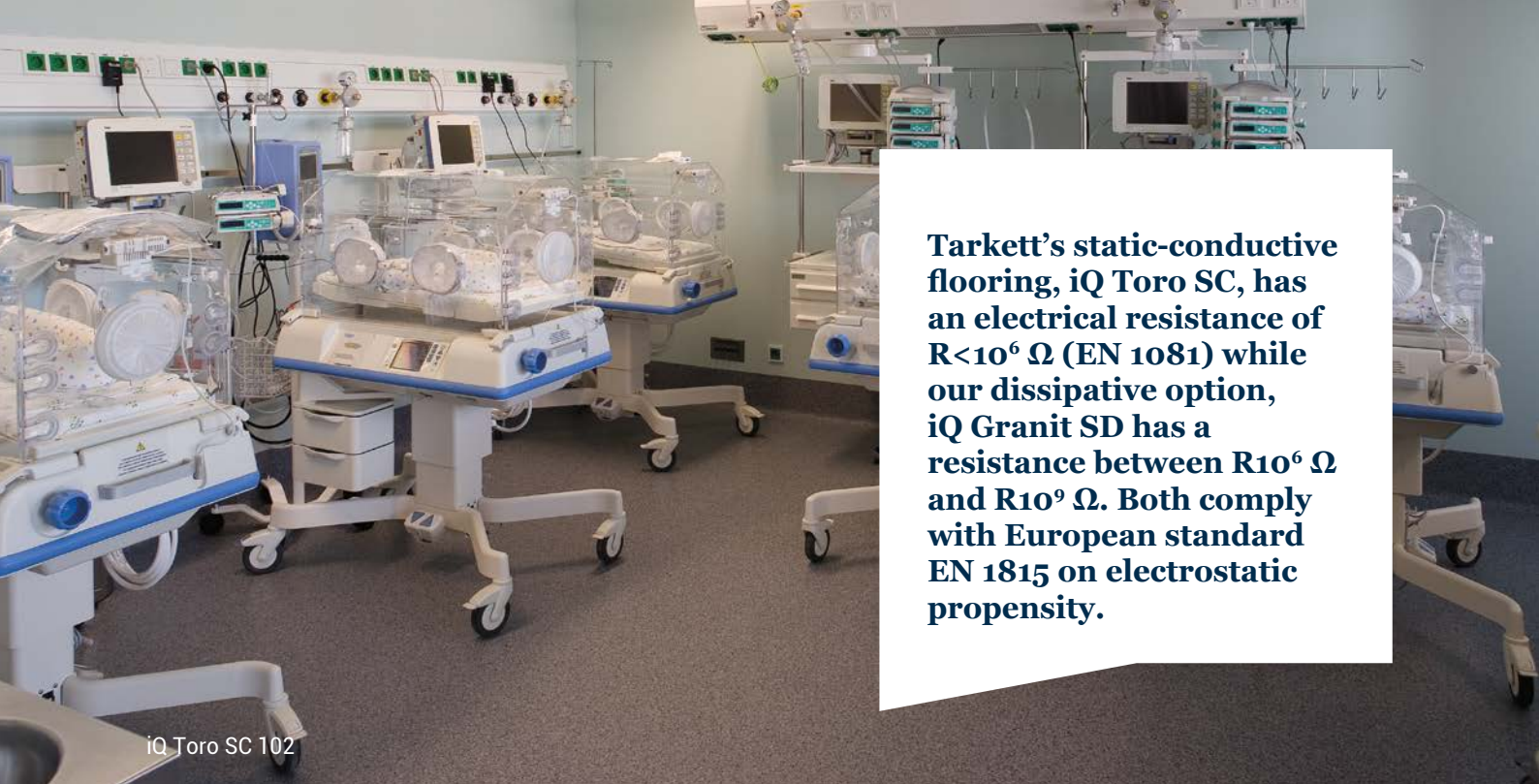

Tarkett's static-conductive flooring, iQ Toro SC, has an electrical resistance of $R < 10^6 \Omega$ (EN 1081) while our dissipative option, iQ Granit SD has a resistance between $R 10^6 \Omega$ and $R 10^9 \Omega$. Both comply with European standard EN 1815 on electrostatic propensity.

iQ Toro SC 102

Flooring plays an important role by conducting electrical charges to a ground point. Conductive floor coverings have a lower electrical resistance and are often recommended for operating theatres where delicate surgery, such as cardiology or neurology, is performed. Dissipative floors have a higher resistance and conduct static more slowly, but they prevent discharge to and from human contact. The flooring to use will depend upon the nature of the medical equipment installed in the room.

Electrical resistance is the measure of the floor material's or the floor construction's capacity to conduct electrical charges to a ground point. The higher the resistance, the lower the conductivity.

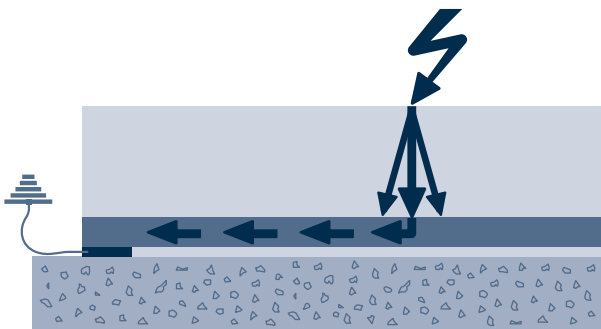

Earth connecting iQ Toro SC / iQ Granit SD

A 100 cm copper strip is placed lengthways under transversal joints

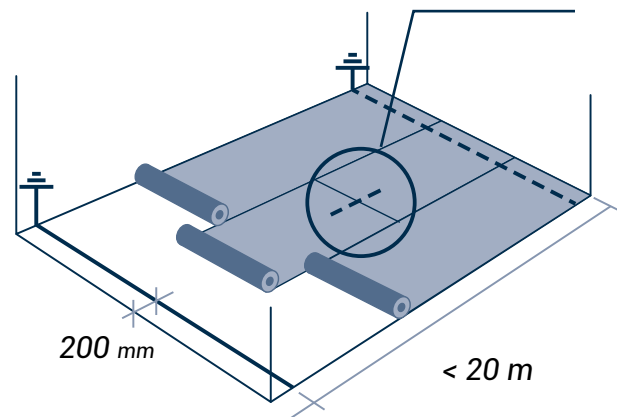

Technical data	Standards	iQ Toro SC	iQ Granit SD
Electrical insulation	VDE 100, Part 600	$R_i \leq 5 \times 10^4 \Omega$	$R_i \leq 5 \times 10^4 \Omega$
Static electrical charge	EN 1815	< 2kV	< 2kV
Electrical resistance	ESD-approval SP-method 2472 EN 1081	$R \leq 10^6$ ohms $R_1, 5 \times 10^4 \leq R \leq 10^6$ ohms $R_2, 5 \times 10^4 \leq R \leq 10^6$ ohms	$10^6 \leq R \leq 10^8$ ohms $R_1 \leq 10^8$ ohms $R_2 \leq 10^8$ ohms

iQ Toro SC and iQ Granit SD unique carbon backing is static-conductive, eliminating the need for conductive adhesive during installation (except over copper strip).

A PROTECTIVE SKIN FOR CLEANROOMS THAT IS HYGIENIC, SAFE, DURABLE AND COMFORTABLE TO WORK IN

THE HIGH PERFORMANCE WALL SOLUTIONS

■ ProtectWall CR



■ Wallgard



FLOORING SOLUTIONS

Non-conductive / Non-dissipative flooring



■ iQ Optima

■ iQ Eminent

■ iQ Granit

■ iQ Natural*

Conductive / Dissipative flooring

■ iQ Toro SC

■ iQ Granit SD

ACCESSORIES

that simplify cleaning and provide a perfect finish

■ Colour-coordinated welding rods

■ PA40 floor and wall cove former

■ Accessory for internal corner

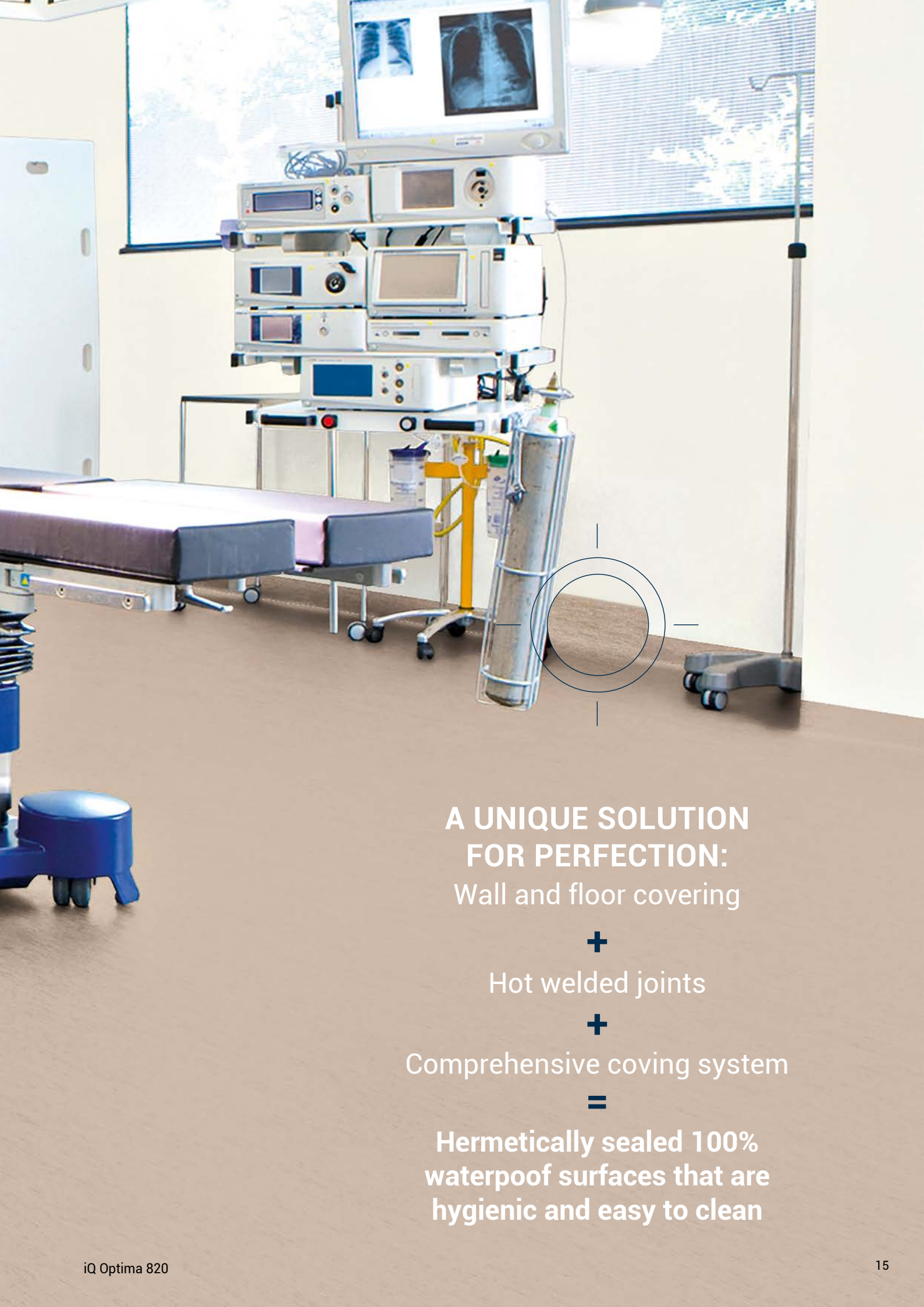

**A UNIQUE SOLUTION
FOR PERFECTION:**
Wall and floor covering

+

Hot welded joints

+

Comprehensive coving system

=

**Hermetically sealed 100%
waterproof surfaces that are
hygienic and easy to clean**

TARKETT iQ: THE RANGE FOR EVERY CLEANROOM NEED

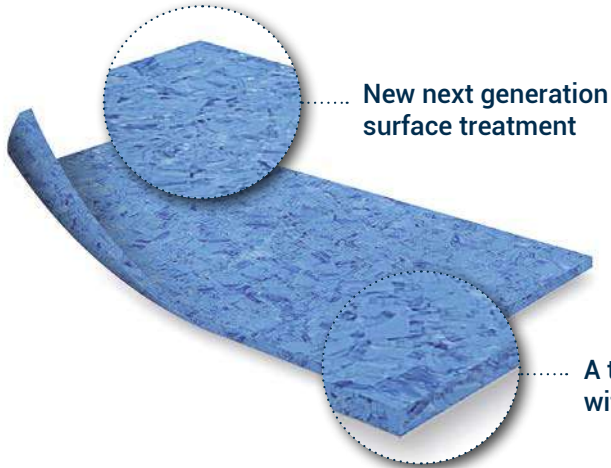

A truly homogeneous flooring with a 2mm wear layer.



iQ Granit

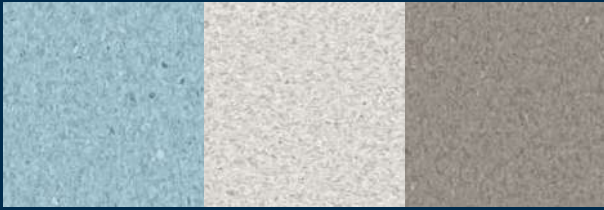

iQ Granit 369

iQ Granit 124

iQ Granit 297

iQ Eminent

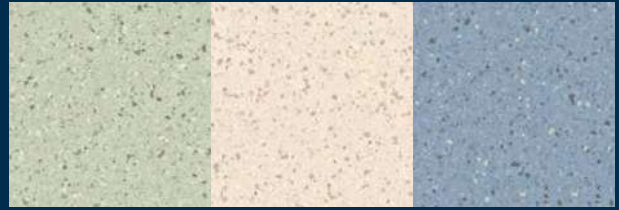

iQ Eminent 892

iQ Eminent 885

iQ Eminent 889

iQ Optima



iQ Optima 856

iQ Optima 826

iQ Optima 208

iQ Natural*

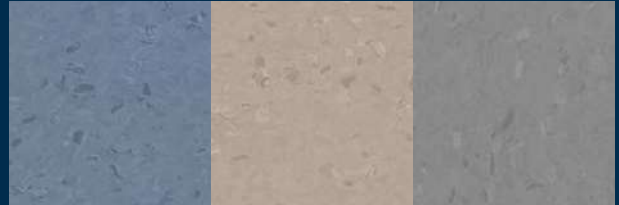

iQ Natural 210

iQ Natural 840

iQ Natural 042

* iQ Natural meets ISO3 requirements

Discover all of our collections and the complete range of colours at professionals.tarkett.com



Particle emissions: rated ISO 3 (iQ Natural) and ISO 4 (ISO 14644-1)



Highly resistant to chemical substances: ISO 26987 – rated 'excellent'



Highly resistant to bacteria: ISO 846 – does not encourage bacterial growth



Excellent cleanability proven by Fraunhofer



Withstands heavy loads of 50kg / cm²



Very low TVOC level <10µg/m³



Excellent durability based on 100 years of flooring expertise



Excellent* ease of decontamination ISO 8690

*Tarkett level certified by the Fraunhofer Institute.

ACCESSORIES

Colour-coordinated welding rods

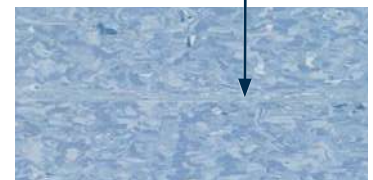

Cove former PA40

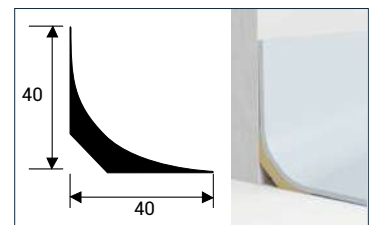

Internal corner

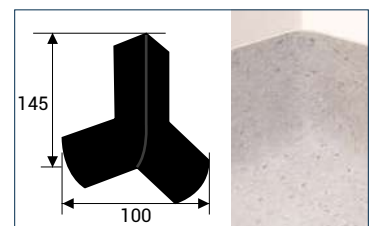

STATIC-DISSIPATIVE AND STATIC-CONDUCTIVE SOLUTIONS

Static-dissipative iQ Granit SD

$R_x \leq 10^8 \Omega$



A truly homogeneous flooring
with a 2mm wear layer



Static-conductive iQ Toro SC

$R_x \leq 10^6 \Omega$



A truly homogeneous with copper shavings
and a 2mm wear layer



Technical data	Standards	iQ Toro SC	iQ Granit SD
Electrical insulation	VDE 100, Part 600	$R_i \leq 5 \times 10^4 \Omega$	$R_i \leq 5 \times 10^4 \Omega$
Static electrical charge	EN 1815	< 2kV	< 2kV
Electrical resistance	ESD-approval SP -method 2472 EN 1081	$R \leq 10^6$ ohms $R_1 5 \times 10^4 \leq R \leq 10^6$ ohms $R_2 5 \times 10^4 \leq R \leq 10^6$ ohms	$10^6 \leq R \leq 10^8$ ohms $R_1 \leq 10^8$ ohms $R_2 \leq 10^8$ ohms

iQ Granit SD

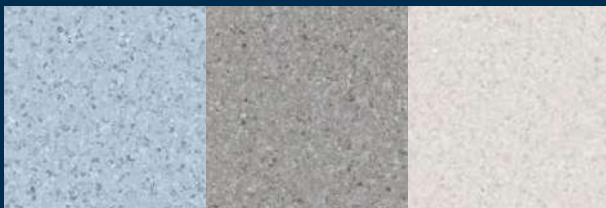

iQ Granit SD 476

iQ Granit SD 949

iQ Granit SD 395

iQ Toro SC



iQ Toro SC 956

iQ Toro SC 960

iQ Toro SC 102

Discover all of our collections and the complete range of colours at professionals.tarkett.com



iQ Toro SC 957

iQ Toro SC 960



Particle emissions: rated ISO 4 (ISO 14644-1)



iQ Granit SD: static-dissipative flooring with an electrical resistance of $R 10^6$ to $10^9 \Omega$



iQ Toro SC: static-conductive flooring with an electrical resistance of $R < 10^6 \Omega$



Highly resistant to chemical substances:
ISO 26987 - rated 'excellent'



Highly resistant to bacteria:
ISO 846 – does not encourage bacterial growth



Easy to maintain - smooth surface, forms a perfect seal with walls



Withstands heavy loads of $50\text{kg} / \text{cm}^2$



Very low TVOC level $< 10\mu\text{g}/\text{m}^3$



Excellent durability based on 100 years of flooring expertise

ACCESSORIES

Static control copper strip

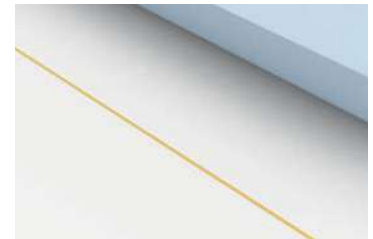

Colour-coordinated welding rods

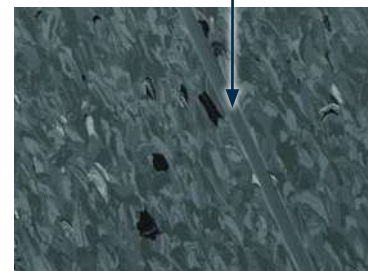

Cove former PA40

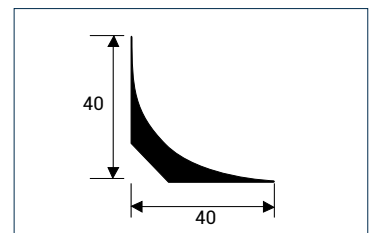

HIGH PERFORMANCE WALL COVERINGS

Unique solution combining complete continuity between wall and floor with excellent cleaning performance and the avoidance of dust.

ProtectWall CR

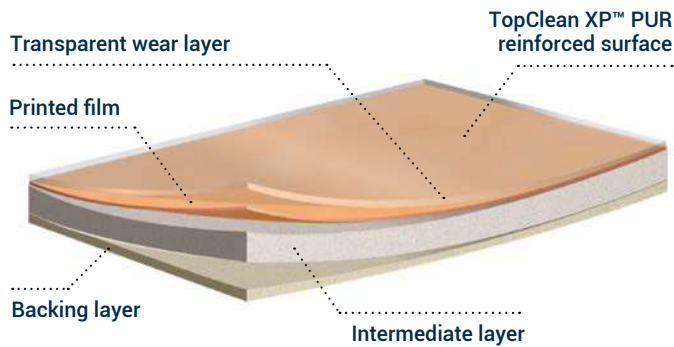

Wallgard 1.3mm

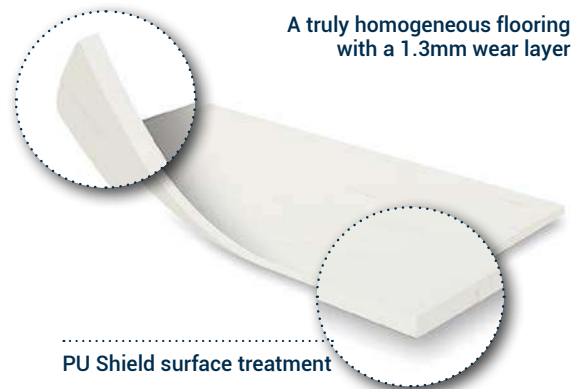

ProtectWALL CR (1.5mm thickness)

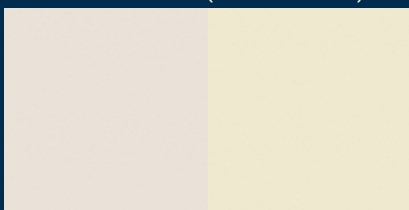

264992062

264992063

Wallgard (1.3mm thickness)

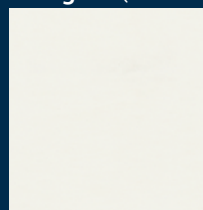

Discover all of our collections and the complete range of colours at professionals.tarkett.com



ProtectWall 062



Particle emissions: Classified ISO 5 (ISO-14644-1) for ProtectWall CR and ISO 4 for Wallgard



Highly resistant to chemical substances: ISO 26987 - rated 'excellent'



Exceptional impact resistance: Sclerometer test – excellent performance with no scratch visible to the naked eye



Very low TVOC level <math><10\mu\text{g}/\text{m}^3</math>



Highly resistant to bacteria: ISO 846 – does not encourage bacterial growth

ACCESSORIES

Colour-coordinated welding rods



Hot welding and perfectly sealed joints offer excellent resistance and hygiene.

Cove former PA40

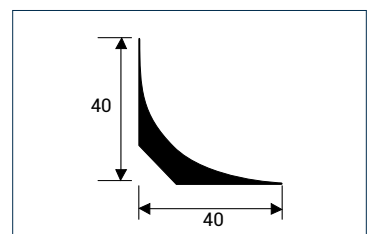

iQ OPTIMA technical data

CERTIFICATION & CLASSIFICATION	STANDARDS	iQ Optima
Type of floor covering	EN ISO 10581 - Compact	Homogeneous vinyl flooring
	EN ISO 11638 - Acoustic	-
Binder content	EN ISO 10581 - Compact	Type I
	EN ISO 11638 - Acoustic	-
Classification	ISO 10874	Commercial: 34 Industrial: 43
Certification	EN 14041	Yes
TECHNICAL CHARACTERISTICS		
iQ Surface treatment		Yes
Total thickness	ISO 24346	2.0 mm
Wear layer thickness	EN ISO 24340	2.0 mm
Total weight	ISO 23997	2700 g/m ²
Form of delivery	ISO 24341 Sheet (rolls)	iQ Optima Approx. 25 lm x 200 cm Art. no. 3242_ _ _3 digit colour colour number
		iQ Optima Essence Approx. 25 lm x 200 cm Art. no. 3077_ _ _3 digit colour colour number
	ISO 24342 Tiles (box)	iQ Optima 61.0 x 61.0 cm - 14 tiles/box = 5.21 m ² Art. no. 3217_ _ _3 digit colour colour number
		iQ Optima Essence 61.0 x 61.0 cm - 14 tiles/box = 5.21 m ² Art. no. 3080_ _ _3 digit colour colour number
TECHNICAL PERFORMANCES		
Dimensional stability	EN ISO 23999	0.40 % for rolls 0.25 % for tiles
Reaction to fire	EN 13501-1 EN ISO 9239-1 EN ISO 11925-2	Class Bfl s1 ≥ 8 kW/m ² Pass
Residual indentation	EN ISO 24343-1	Required value: ≤ 0.10 mm Best measured value: 0.02 mm
Castor chair test	ISO 4918 - EN 425	Suitable
Static electrical discharge	EN 1815	< 2 kV
Cleanroom	ASTM F51/00 ISO 14644-1	Class A ISO class 4
Total VOC emissions	ISO 16000-6	≤ 10 µg/m ³ (after 28 days)
Underfloor heating		Suitable – max 27°C
Light fastness	EN ISO 105-B02, Method 3a	≥ level 7
Ease of decontamination	ISO 8690 – DIN 25415	Excellent
Chemical resistance	ISO 26987	Excellent
Bacteria resistance	ISO 846 - Part C	Does not favour growth
Slip resistance	DIN 51130	R9
	EN 13893	≥ 0.3
Curl resistance to heat	EN ISO 23999	No damage
Impact sound reduction	EN ISO 717/2	-
Acoustic improvement	NF S31-074	-
Barefoot test	DIN 51097	-
Seam strength	EN 684	Average value: 240 N/50 mm Individual values: 180 N/50 mm
Thermal conductivity	EN 12667	0.01 m ² K/W
Colours		Original: 48 Mono: 10 / Essence: 6

The above information is subject to modification for the benefit of further improvement (08/17).
Tarkett's instructions regarding installation, cleaning and maintenance should be observed.
Please contact Tarkett at the address shown for these instructions.

CUSTOMS TARIFF: 482050000000F





Tarkett AB
Report No. TA 1108-567

Cleanroom[®] Suitable Materials

iQ Optima
Particle (vs. PA6 Nylon): ISO 4

Flooring & Coating

Qualification Certificate

We hereby certify that the material stated above, provided by

Tarkett AB

372 73 Ronneby
Sweden

has been awarded the Fraunhofer IPA CSM Certificate of Qualification with the report number TA 1108-567.

The tests performed in accordance with CSM procedures included particle emission during the application of frictional stress. The tested material obtained the following classification in accordance with the standard listed below.

Material (Mat.)	iQ Optima	
Particle	Reel-on-disc test; Normal force 300N Mat. vs. PA6 Nylon	suitable for ISO Class 4 (see ISO 14644-1)

Detailed test information regarding the sample (serial number, color, batch number etc.), environment and parameters used, can be obtained from the CSM test report TA 1108-567 issued by the Fraunhofer-Gesellschaft.

Stuttgart, September 20, 2011

J. A.
Project manager

The validity of this certificate is temporary indefinite and limited to the named product. It can be verified on www.tested-device.com.

For more CSM information, please visit www.ipa-csm.com.

DUPLICATE

Fraunhofer
IPA

iQ GRANIT technical data

CERTIFICATION & CLASSIFICATION	STANDARDS	iQ Granit
Type of floor covering	ISO 10581	Homogeneous single layered vinyl flooring
Declaration of performance	EN 14041	0019-0009-DoP-2013-07
Binder content	ISO 10581	Type I
Classification	ISO 10874	Commercial: 34 Industrial: 43
Recyclable	ISO 14021	Yes, post installation and post use

TECHNICAL CHARACTERISTICS		
Surface treatment		iQ
Surface restoration		Yes
Total thickness	ISO 24346	2.0 mm
Wear layer thickness	ISO 24340	2.0 mm
Total weight	ISO 23997	2750 g/m ²
Form of delivery iQ Granit	ISO 24341 Sheet (rolls)	Approx. 25 running metres x 200 cm Art. no. 21142_ __ 3 digit colour number
	ISO 24342 Tiles (box)	61.0 x 61.0 cm – 14 tiles/box = 5.21 m ² Art. no. 21143_ __ 3 digit colour number
Form of delivery iQ Granit bio-attributed	ISO 24341 Sheet (rolls)	Approx. 25 running metres x 200 cm Art. no. 21144_ __ 3 digit colour number
	ISO 24342 Tiles (box)	61.0 x 61.0 cm – 14 tiles/box = 5.21 m ² Art. no. 21145_ __ 3 digit colour number

TECHNICAL PERFORMANCES		
Reaction to fire	EN 13501-1 EN ISO 9239-1 EN ISO 11925-2	Class B _s s1 ≥ 8 kW/m ² Pass
Marine equipment	IMO FTPS Part 5 and 2 IMO Res. A653	 0575
Residual indentation	ISO 24343-1	Required value: ≤ 0.10 mm Best measured value: 0.02 mm
Castor chair test	ISO 4918	Suitable
Static electrical discharge	EN 1815 On any surface ≤ 10 ⁹ Ω	< 2 kV
Clean room	ISO 14644-1	ISO class 4
Riboflavin test	Fraunhofer method	Class 0: Excellent
Total VOC emissions	ISO 16000-6 Indoor air quality FloorScore	≤ 10 µg/m ³ (after 28 days) Platinum SCS certified
Underfloor heating		Suitable – max 27°C
Light fastness	EN ISO 105-B02	≥ level 7
Ease of decontamination	ISO 8690 – DIN 25415	Excellent
Chemical resistance	ISO 26987	Excellent
Bacteria resistance	ISO 846:Part C	Does not favour growth
Slip resistance	DIN 51130 EN 13893 BS 7976-2	R9 ≥ 0.3 Low risk of slip
Wet room approval	EN 13553 Annex A	Watertight

COLOURS

50

The above information is subject to modification for the benefit of further improvement (04/2021).

According to the European Regulation N° 305/2011 for CE Marking, the Declarations of Performance are available on our website www.tarkett.com. Tarkett's instructions regarding installation, cleaning and maintenance should be observed. Please contact Tarkett at the address shown for these instructions.

CUSTOMS TARIFF : 482050000000F





Tarkett AB
Report No. TA 1108-567

Cleanroom[®] Suitable Materials

iQ Granit
Particle (vs. PA6 Nylon): ISO 4

Flooring & Coating

Qualification Certificate

We hereby certify that the material stated above, provided by

Tarkett AB

372 73 Ronneby
Sweden

has been awarded the Fraunhofer IPA CSM Certificate of Qualification with the report number TA 1108-567.

The tests performed in accordance with CSM procedures included particle emission during the application of frictional stress. The tested material obtained the following classification in accordance with the standard listed below.

Material (Mat.)	iQ Granit	
Particle	Reel-on-disc test; Normal force 300N Mat. vs. PA6 Nylon	suitable for ISO Class 4 (see ISO 14644-1)

Detailed test information regarding the sample (serial number, color, batch number etc.), environment and parameters used, can be obtained from the CSM test report TA 1108-567 issued by the Fraunhofer-Gesellschaft.

Stuttgart, September 20, 2011

i. A. 
Project manager

DUPLICATE

The validity of this certificate is temporary indefinite and limited to the named product. It can be verified on www.tested-device.com.

For more CSM information, please visit www.ipa-csm.com.



iQ EMINENT technical data

CERTIFICATION & CLASSIFICATION	STANDARDS	iQ Eminent
Type of floor covering	ISO 10581	Pressed homogeneous single layered vinyl flooring
Declaration of performance	EN 14041	0019-0008-DoP-2013-07
Binder content	ISO 10581	Type I
Classification	ISO 10874	Commercial: 34 Industrial: 43
Recyclable	ISO 14021	Yes, post installation and post use

TECHNICAL CHARACTERISTICS		
Surface treatment		iQ
Surface restoration		Yes
Total thickness	ISO 24346	2.0 mm
Wear layer thickness	ISO 24340	2.0 mm
Total weight	ISO 23997	2750 g/m ²
Form of delivery iQ Eminent	ISO 24341 Sheet (rolls)	Approx. 23 running metres x 200 cm Art. no. 21030_ _ _ 3 digit colour number
	ISO 24342 Tiles (box)	61.0 x 61.0 cm – 14 tiles/box = 5.21 m ² Art. no. 21031_ _ _ 3 digit colour number
Form of delivery iQ Eminent bio-attributed	ISO 24341 Sheet (rolls)	Approx. 23 running metres x 200 cm Art. no. 21146_ _ _ 3 digit colour number
	ISO 24342 Tiles (box)	61.0 x 61.0 cm – 14 tiles/box = 5.21 m ² Art. no. 21147_ _ _ 3 digit colour number

TECHNICAL PERFORMANCES		
Reaction to fire	EN 13501-1 EN ISO 9239-1 EN ISO 11925-2	Class B _{fl} s1 ≥ 8 kW/m ² Pass
Residual indentation	ISO 24343-1	Required value: ≤ 0.10 mm Best measured value: 0.02 mm
Castor chair test	ISO 4918	Suitable
Static electrical discharge	EN 1815 On any surface ≤ 10 ⁹ Ω	< 2 kV
Clean room	ISO 14644-1	ISO class 4
Riboflavin test	Fraunhofer method	Class 0: Excellent
Total VOC emissions	ISO 16000-6 Indoor air quality FloorScore	≤ 10 µg/m ³ (after 28 days) Platinum SCS certified
Underfloor heating		Suitable – max 27°C
Light fastness	EN ISO 105-B02	≥ level 7
Ease of decontamination	ISO 8690 – DIN 25415	Excellent
Chemical resistance	ISO 26987	Excellent
Bacteria resistance	ISO 846:Part C	Does not favour growth
Slip resistance	DIN 51130 EN 13893 BS 7976-2	R9 ≥ 0.3 Low risk of slip
Wet room approval	EN 13553 Annex A	Watertight

COLOURS

26

The above information is subject to modification for the benefit of further improvement (04/2021).
According to the European Regulation N° 305/2011 for CE Marking, the Declarations of Performance are available on our website www.tarkett.com
Tarkett's instructions regarding installation, cleaning and maintenance should be observed. Please contact Tarkett at the address shown for these instructions.

CUSTOMS TARIFF: 482050000000F





Tarkett AB
Report No. TA 1403-699

Cleanroom[®] Suitable Materials

iQ Eminent
 Particle (vs. PA6): ISO 4

Flooring & Coating

Qualification Certificate

We hereby certify that the material stated above, provided by

Tarkett AB
 Ronneby, Sweden

has been awarded the Fraunhofer IPA CSM Certificate of Qualification with the report number TA 1403-699.

iQ Eminent (color 088) was tested regarding particle emission during the application of frictional stress according to VDI 2083-17. The tested material obtained the following classification:

Material pairing and test		Suitable for Air Cleanliness Class (ISO 14644-1)
iQ Eminent (color 088)	vs. PA6	ISO Class: 4
Reel-on-disc test Normal force 300 N		

Detailed information regarding specific product data such as date of manufacture and serial number as well as test environment and parameters can be obtained from the CSM test report issued by the Fraunhofer-Gesellschaft.

Stuttgart, September 1, 2014

i. A. 
 Project manager

DUPLICATE

The validity of this certificate is temporary indefinite and limited to the named product. It can be verified on www.tested-device.com.

For more CSM information, please visit www.ipa-csm.com.



iQ NATURAL technical data

CERTIFICATION & CLASSIFICATION	STANDARDS	iQ Natural	iQ Natural Acoustic
Type of floor covering	EN 10581	Homogeneous single layered vinyl flooring with renewable plasticizer	-
	EN ISO 11638	-	Homogeneous vinyl flooring with foam interlayer
Wear layer binder content	EN ISO 10581	Type I	-
	EN ISO 11638	-	Type II
Classification	EN ISO 10874	Commercial: 34 Industrial: 43	Commercial: 34 Industrial: 42

TECHNICAL CHARACTERISTICS			
Total thickness	EN ISO 24346	2.0 mm	3.5 mm
Total weight	EN ISO 23997	2800 g/m ²	4000 g/m ²
Wear layer thickness	EN ISO 24340	2.0 mm	2.0 mm
Surface treatment		New iQ PUR	New iQ PUR
Form of delivery	EN ISO 24341 Sheet (rolls)	Approx. 23 running metres x 200 cm Art. no. 21103_ _ _ 3 digit colour colour number	Approx. 23 running metres x 195 cm Art. no. 21121_ _ _ 3 digit colour colour number
	ISO 24342 Tiles (box)	61 x 61 cm - 14 tiles/box = 5.21 m ² Art. no. 21104_ _ _ 3 digit colour colour number	-

PERFORMANCES FOR CE MARKING REQUIREMENTS (EN 14041)			
Declaration of Performance	EN 14041	0019-0007-DoP-2013-07	0019-0046-DoP-2020-02
Reaction to fire	EN 13501-1 EN ISO 9239-1 EN ISO 11925-2	Class Bfl s1 ≥ 8 kW/m ² Pass	Class Bfl s1 ≥ 8 kW/m ² Pass
Static electrical discharge	EN 1815	< 2.0 kV	< 2.0 kV
Thermal resistance	EN 12667	Approx. 0.01 m ² K/W	-
Slip resistance	EN 13893 BS 7976-2	μ ≥ 0.30 Low risk of slip	μ ≥ 0.30 Low risk of slip

TECHNICAL PERFORMANCES			
Residual indentation	ISO 24343-1	Required value: ≤ 0.10 mm Best measured value*: 0.02 mm	-
Impact sound reduction	EN ISO 717 / 2	-	ΔLw = 15 dB
Slip resistance	DIN 51130	R9	R9
Cleanroom test	ISO 14644-1	ISO class 3	-
Castor chair	ISO 4918	Suitable	Suitable
Light fastness	EN ISO 105-B02	≥ 7	≥ 7
Dimensional stability	EN ISO 23999	≤ 0.40% for rolls ≤ 0.25% for tiles	≤ 0.40% for rolls -
Chemical resistance	EN ISO 26987	Excellent	Excellent
Ease of decontamination	ISO 8690	Excellent	Excellent
Bacteria resistance	ISO 846 Part C	Does not favour growth	Does not favour growth
Underfloor heating		Suitable - max. 27°C	Suitable - max. 27°C
Seam strength	EN 684	Average value: ≥ 240 N/50mm Individual values: ≥ 180 N/50mm	Average value: ≥ 240 N/50mm Individual values: ≥ 180 N/50mm
Colours		35	10

ENVIRONMENTAL PERFORMANCES			
Total VOC emissions	ISO 16000-9	≤ 10 µg/m ³ (after 28 days)	≤ 10 µg/m ³ (after 28 days)

The above information is subject to modification for the benefit of further improvement (02/20). *For information - not binding.

According to the European Regulation N° 305/2011 for CE Marking, the Declarations of Performance are available on our website www.tarkett.com

Tarkett's instructions regarding installation, cleaning and maintenance should be observed. Please contact Tarkett at the address shown for these instructions.

CUSTOMS TARIFF : 482050000000F

iQ Natural	iQ Natural Acoustic	Welding Rod No.	iQ Natural	iQ Natural Acoustic	Welding Rod No.	iQ Natural	iQ Natural Acoustic	Welding Rod No.	iQ Natural	iQ Natural Acoustic	Welding Rod No.	iQ Natural	iQ Natural Acoustic	Welding Rod No.
042	-	1296 040	159	-	1296 045	210	-	1296 051	480	480	1296 056	840	840	1296 060
057	057	1296 041	182	-	1296 046	235	-	1296 052	481	481	1296 056	842	-	1296 008
071	071	1296 041	183	-	1296 047	241	241	1296 053	486	-	1296 012	844	-	1296 061
075	-	1296 004	184	-	1296 048	381	381	1296 053	489	-	1296 057	846	-	1296 062
081	-	1296 042	185	185	1296 049	385	-	1296 034	490	-	1296 058	858	-	1296 063
096	-	1296 043	186	186	1296 049	402	-	1296 054	491	-	1296 059	859	-	1296 064
108	-	1296 044	187	-	1296 050	403	-	1296 055	832	832	1296 060	868	-	1296 065





Tarkett AB
Report No. TA 1403-699

Cleanroom[®] Suitable Materials

iQ Natural
 Particle (vs. PA6): ISO 3

Flooring & Coating

Qualification Certificate

We hereby certify that the material stated above, provided by

Tarkett AB
 Ronneby, Sweden

has been awarded the Fraunhofer IPA CSM Certificate of Qualification with the report number TA 1403-699.

iQ Natural (color 172) was tested regarding particle emission during the application of frictional stress according to VDI 2083-17. The tested material obtained the following classification:

Material pairing and test		Suitable for Air Cleanliness Class (ISO 14644-1)
iQ Natural (color 172)	vs. PA6	ISO Class: 3
Reel-on-disc test Normal force 300N		

Detailed information regarding specific product data such as date of manufacture and serial number as well as test environment and parameters can be obtained from the CSM test report issued by the Fraunhofer-Gesellschaft.

Stuttgart, September 1, 2014

i. A. 
 Project manager

DUPLICATE

The validity of this certificate is temporary indefinite and limited to the named product. It can be verified on www.tested-device.com.

For more CSM information, please visit www.ipa-csm.com.



iQ GRANIT SD technical data

CERTIFICATION & CLASSIFICATION	STANDARDS	iQ Granit SD
Type of floor covering	ISO 10581	Permanently static dissipative pressed homogeneous vinyl flooring
Declaration of performance	EN 14041	0019-0033-DoP-2013-07
Binder content	ISO 10581	Type I
Classification	ISO 10874	Commercial: 34 Industrial: 43
Recyclable	ISO 14021	Yes, post installation and post use

TECHNICAL CHARACTERISTICS		
Surface treatment		iQ
Surface restoration		Yes
Total thickness	ISO 24346	2.0 mm
Wear layer thickness	ISO 24340	2.0 mm
Total weight	ISO 23997	2800 g/m ²
Form of delivery	ISO 24341	Approx. 23 running metres x 200 cm
iQ Granit SD	Sheet (rolls)	Art. no. 3096_ _ _ 3 digit colour colour number
	ISO 24342	61.0 x 61.0 cm – 14 tiles/box = 5.21 m ²
	Tiles (box)	Art. no. 3097_ _ _ 3 digit colour number

TECHNICAL PERFORMANCES		
Reaction to fire	EN 13501-1 EN ISO 9239-1 EN ISO 11925-2	Class B _{fl} s1 ≥ 8 kW/m ² Pass
Residual indentation	ISO 24343-1	Required value: ≤ 0.10 mm Best measured value: 0.02 mm
Castor chair test	ISO 4918	Suitable
Static electrical discharge	EN 1815 On any surface ≤ 10 ⁹ Ω	< 2 kV
Electrical insulation	VDE 0100, Part 600	R _i ≥ 5x10 ⁴ Ohms
Electrical resistance	ESD-approval SP method 2472 EN 1081 EN/IEC 61340-4-1	R ≤ 10 Ohms R ₁ ≤ 10 ⁸ Ohms R ₂ ≤ 10 ⁸ Ohms R ≤ 10 ⁸ Ohms
Clean room	ISO 14644-1	ISO class 4
Total VOC emissions	ISO 16000-6 Indoor air quality FloorScore	≤ 10 µg/m ³ (after 28 days) Platinum SCS certified
Underfloor heating		Suitable – max 27°C
Light fastness	EN ISO 105-B02	≥ level 7
Ease of decontamination	ISO 8690 – DIN 25415	Excellent
Chemical resistance	ISO 26987	Excellent
Bacteria resistance	ISO 846:Part C	Does not favour growth
Slip resistance	DIN 51130 EN 13893 BS 7976-2	R9 ≥ 0.3 Low risk of slip

COLOURS

14

The above information is subject to modification for the benefit of further improvement (05/2021).

According to the European Regulation N° 305/2011 for CE Marking, the Declarations of Performance are available on our website www.tarkett.com

Tarkett's instructions regarding installation, cleaning and maintenance should be observed. Please contact Tarkett at the address shown for these instructions.

CUSTOMS TARIFF : 482050000000F





Tarkett AB
Report No. TA 1304-646

Cleanroom[®] Suitable Materials

iQ Granit SD
 Particle (vs. PA6): ISO 4

Flooring & Coating

Qualification Certificate

We hereby certify that the material stated above, provided by

Tarkett AB
 Ronneby, Sweden

has been awarded the Fraunhofer IPA CSM Certificate of Qualification with the report number TA 1304-646.

iQ Granit SD (color 710) was tested regarding particle emission during the application of frictional stress according to VDI 2083-17. The tested material obtained the following classification:

Material pairing and test		Suitable for Air Cleanliness Class (ISO 14644-1)
iQ Granit SD; color 710	vs. PA6	ISO Class: 4
Reel-on-disc test Normal force 300 N		

Detailed information regarding specific product data such as date of manufacture, color, and serial number as well as test environment and parameters can be obtained from the CSM test report issued by the Fraunhofer-Gesellschaft.

Stuttgart, June 26, 2013

i. A. 
 Project manager

DUPLICATE

The validity of this certificate is temporary indefinite and limited to the named product. It can be verified on www.tested-device.com.

For more CSM information, please visit www.ipa-csm.com.



iQ TORO SC technical data

CERTIFICATION & CLASSIFICATION	STANDARDS	iQ Toro SC
Type of floor covering	ISO 10581	Permanently static conductive pressed homogeneous vinyl flooring
Declaration of performance	EN 14041	0019-0038-DoP-2013-07
Binder content	ISO 10581	Type I
Classification	ISO 10874	Commercial: 34 Industrial: 43
Recyclable	ISO 14021	Yes, post installation and post use

TECHNICAL CHARACTERISTICS		
Surface treatment		iQ
Surface restoration		Yes
Total thickness	ISO 24346	2.0 mm
Wear layer thickness	ISO 24340	2.0 mm
Total weight	ISO 23997	2800 g/m ²
Form of delivery	ISO 24341	Approx. 23 running metres x 200 cm
iQ Toro SC	Sheet (rolls)	Art. no. 3093_ _ _ 3 digit colour colour number
	ISO 24342	61.0 x 61.0 cm – 14 tiles/box = 5.21 m ²
	Tiles (box)	Art. no. 3094_ _ _ 3 digit colour number

TECHNICAL PERFORMANCES		
Reaction to fire	EN 13501-1 EN ISO 9239-1 EN ISO 11925-2	Class B ₁ s1 ≥ 8 kW/m ² Pass
Residual indentation	ISO 24343-1	Required value: ≤ 0.10 mm Best measured value: 0.02 mm
Castor chair test	ISO 4918	Suitable
Static electrical discharge	EN 1815 On any surface ≤ 10 ⁹ Ω	< 2 kV
Electrical insulation	VDE 0100, Part 600	R ≤ 5x10 ⁴ Ohms
Electrical resistance	ESD-approval SP method 2472 EN 1081 EN/IEC 61340-4-1, 100 V EN/IEC 61340-4-5	R ≤ 10 ⁹ Ohms R ₁ : 5x10 ⁴ ≤ R ≤ 10 ⁶ Ohms R ₂ : 5x10 ⁴ ≤ R ≤ 10 ⁶ Ohms R 5x10 ⁴ ≤ R ≤ 10 ⁶ Ohms ≤ 3,5x10 ⁷ Ohms
Clean room	ISO 14644-1	ISO class 4
Total VOC emissions	ISO 16000-6 Indoor air quality FloorScore	≤ 10 µg/m ³ (after 28 days) Platinum SCS certified
Underfloor heating		Suitable – max 27°C
Light fastness	EN ISO 105-B02	≥ level 7
Ease of decontamination	ISO 8690 – DIN 25415	Excellent
Chemical resistance	ISO 26987	Excellent
Bacteria resistance	ISO 846:Part C	Does not favour growth
Slip resistance	DIN 51130 EN 13893 BS 7976-2	R9 ≥ 0.3 Low risk of slip

COLOURS

14

The above information is subject to modification for the benefit of further improvement (05/2021).

According to the European Regulation N° 305/2011 for CE Marking, the Declarations of Performance are available on our website www.tarkett.com

Tarkett's instructions regarding installation, cleaning and maintenance should be observed. Please contact Tarkett at the address shown for these instructions.

CUSTOMS TARIFF : 482050000000F





Tarkett AB
Report No. TA 1304-646

Cleanroom[®] Suitable Materials

iQ Toro SC
 Particle (vs. PA6): ISO 3

Flooring & Coating

Qualification Certificate

We hereby certify that the material stated above, provided by

Tarkett AB
 Ronneby, Sweden

has been awarded the Fraunhofer IPA CSM Certificate of Qualification with the report number TA 1304-646.

iQ Toro SC (color 100) was tested regarding particle emission during the application of frictional stress according to VDI 2083-17. The tested material obtained the following classification:

Material pairing and test		Suitable for Air Cleanliness Class (ISO 14644-1)
iQ Toro SC; color 100	vs. PA6	ISO Class: 3
Reel-on-disc test Normal force 300 N		

Detailed information regarding specific product data such as date of manufacture, color, and serial number as well as test environment and parameters can be obtained from the CSM test report issued by the Fraunhofer-Gesellschaft.

Stuttgart, June 26, 2013

i. A. 
 Project manager

DUPLICATE

The validity of this certificate is temporary indefinite and limited to the named product. It can be verified on www.tested-device.com.

For more CSM information, please visit www.ipa-csm.com.



ProtectWall CR technical data

CERTIFICATION & CLASSIFICATION		STANDARDS	ProtectWall CR (CleanRoom)
Description		EN 259-1	Heavy duty wallcovering
		EN 14644-1	Cleanroom suitable Designed with a dedicated embossing to ensure hygiene in Cleanroom
TECHNICAL CHARACTERISTICS			
Total thickness		EN ISO 24346	1.50 mm
Total weight		EN ISO 23997	2400 g/m ²
Wear layer thickness		EN ISO 24340	0.15 mm
Form of delivery		EN ISO 24341 (rolls)	20 running metres x 200 cm (40m ²)
PERFORMANCES FOR CE MARKING REQUIREMENTS (EN 15102)			
Declaration of Performance		EN 15102	0132-0065-DoP-2022-01
Reaction to fire		EN 13501-1	B-s2,d0 glued on any non-metal A1 or A2-s1,d0 class substrate
TECHNICAL PERFORMANCES			
Light fastness		EN ISO 105-B02	≥ 6
Resistance to impacts		EN 259-2	Resistant to impacts No visible burst nor crack
Spongeability washability Lyability brushability		EN 12956	Super washable and brushable
Determination of Flexibility		ISO 24344	No damage, no crack
Determination of seam strength		EN 684	> 250 N/50 mm
Stain resistance Chemical resistance		ISO 26987	Not Affected (0)
Bacteria resistance		ISO 846 part A and C	Does not favour growth
Contamination control		EN 14644-1	Cleanroom suitable
Ease of decontamination		ISO 8690	Good
ENVIRONMENTAL PERFORMANCES			
Total VOC emissions		ISO 16000	≤ 10 µg/m ³ (after 28 days)
COLOURS			
			2

The above information is subject to modification for the benefit of further improvement (08/17).
Tarkett's instructions regarding installation, cleaning and maintenance should be observed.
Please contact Tarkett at the address shown for these instructions.

CUSTOMS TARIFF : 482050000000F





TARKETT GDL SA
Report No. TA 2201-1292

Cleanroom[®] Suitable Materials

PROTECTWALL 1.5 CR
 Particle (vs. stainless steel): **ISO 5**

FLOORING & COATING

Single product Particle Emission

Qualification Certificate

We hereby certify that the material stated above, provided by

TARKETT GDL SA
 Lentzweiler, Luxembourg

has been awarded the Fraunhofer IPA CSM Certificate of Qualification with the report number TA 2201-1292.

The level of particulate contamination emitted during application of tribological stress on the material pairing specified lies within the permissible values of the corresponding Air Cleanliness Class in accordance with ISO 14644-1:

Material pairing and test		Suitable for Air Cleanliness Class (ISO 14644-1)
ProtectWALL 1.5 CR (white)	vs. stainless steel 1.3541/1.4034	ISO Class: 5
Ball-on-disc test; normal force: 3N		

This document only applies to the named product in its original state and is valid for a period of 5 years from the date the first document was issued. The document can be verified under www.tested-device.com.

Detailed information and parameters of the test environment can be found in the Fraunhofer IPA test report.

TA 2201-1292
 Report No. first document
 --
 Report No. current document

Stuttgart, January 24, 2022
 Place, date of first document issued
 --
 Place, current date

on behalf of 
 Dr.-Ing. Udo Gommel, Project Manager Fraunhofer IPA



Wallgard technical data

CERTIFICATION & CLASSIFICATION		STANDARDS	Wallgard 1.3 mm
Description		EN 259-1	Homogeneous vinyl wall covering
		EN 15102	Yes
TECHNICAL CHARACTERISTICS			
PU-Shield			Yes
Total thickness		ISO 24346 – EN 428	1.3 mm
Total weight/m ²		ISO 23997 – EN 430	3400 g
Form of delivery		ISO 24341 – EN 426 Sheet (rolls)	Approx. 23 running metres x 200 cm Art. no. 21055_ _ _ 3 digit colour colour number
TECHNICAL PERFORMANCES			
Total VOC emissions		ISO 16000-6 AgBB/DIBt	≤ 10 µg/m ³ (after 28 days) Confirm
Reaction to fire		EN 13501-1 AS/NZS 3837	Class B s2 d0 Class B
Airborne particle emissions		ISO 14644-1 ASTM F24 F51	ISO class 4 Class A
Dimensional stability		ISO 23999 – EN 434	≤ 0.40 %
Light fastness		EN ISO 105-B02	≥ level 7
Chemical resistance		ISO 26987 – EN 423	Excellent
Bacteria resistance		ISO 846:Part C	Does not favour growth
Seam strength		EN 684	Average value: ≥ 240 N/50 mm Individual values: ≥ 180 N/50 mm

The above information is subject to modification for the benefit of further improvement (08/17).
Tarkett's instructions regarding installation, cleaning and maintenance should be observed.
Please contact Tarkett at the address shown for these instructions.

CUSTOMS TARIFF: 482050000000F





Tarkett AB
Report No. TA 1411-737

Cleanroom[®] Suitable Materials

Wallgard
 Particle (vs. PA6): ISO 4

Flooring & Coating

Qualification Certificate

We hereby certify that the material stated above, provided by

Tarkett AB
 Ronneby, Sweden

has been awarded the Fraunhofer IPA CSM Certificate of Qualification with the report number TA 1411-737.

Wallgard (color: 3388011/white) was tested regarding particle emission during the application of frictional stress according to VDI 2083-17. The tested material obtained the following classification:

Material pairing and test		Suitable for Air Cleanliness Class (ISO 14644-1)
Wallgard (3388011/white)	vs. PA6	ISO Class: 4
Reel-on-disc test Normal force 300 N		

Detailed information regarding specific product data such as date of manufacture and serial number as well as test environment and parameters can be obtained from the CSM test report issued by the Fraunhofer-Gesellschaft.

Stuttgart, January 20, 2015

i. A. 
 Project manager

DUPLICATE

The validity of this certificate is temporary indefinite and limited to the named product. It can be verified on www.tested-device.com.

For more CSM information, please visit www.ipa-csm.com.





iQ Granit 323



iQ Granit 188



■ **WESTERN EUROPE:** Austria: Tarkett Holding GmbH, Niederlassung Wien – Tel. +43 1 47 88 062 ■ **Belgium:** Tarkett Belux Sprl – Tel. +32 52 26 24 11 ■ **Denmark:** Tarkett A/S – Tel. +45 43 90 60 11 ■ **Finland:** Tarkett Oy – Tel. +358 9 4257 9000 ■ **France:** Tarkett SAS – Tel. +33 1 41 20 42 49 ■ **Germany:** Tarkett Holding GmbH – Tel. +49 62 33 810 ■ **Greece:** Tarkett Monoprosopi Ltd – Tel. +30 210 6745 340 ■ **Italy:** Tarkett S.p.A. – Tel. +39 0744 7551 ■ **Luxembourg:** Tarkett GDL SA – Tel. +352 949 211 8804 ■ **Netherlands:** Tarkett BV – Tel. +31 416 685 491 ■ **Norway:** Tarkett AS – Tel. +47 32 20 92 00 ■ **Portugal:** Tarkett SA – Tel. +351 21 427 64 20 ■ **Spain:** Tarkett Floors S.L – Tel. +34 914 951 400 ■ **Sweden:** Tarkett Sverige AB – Tel. +46 771 25 19 00 ■ **Switzerland:** Tarkett Holding GmbH – Tel. +41 043 233 79 24 ■ **Turkey:** Tarkett Aspen – Tel. +90 212 213 65 80 ■ **United Kingdom:** Tarkett Ltd – Tel. +44 (0) 1622 854 040 ■ **EASTERN EUROPE:** **Baltic Countries:** Estonia: +372 55 515880 ■ **Latvia:** +371 26 112014 ■ **Lithuania:** +370 37 262220 ■ **Czech Republic:** Tarkett org. slozka – Tel: +420 271 001 600 ■ **Hungary:** Tarkett Polska SP Z.O.O. magyarországi fióktelepe – Tel. +36 1 437 8150 ■ **Poland:** Tarkett Polska Sp. z o. o. – Tel. +48 22 16 09 231 ■ **Russian Federation:** ZAO Tarkett RUS – Tel. +7 495 775 3737 ■ **Slovakia:** Tarkett Polska, organizačná zložka – Tel. +421 2 48291 317 ■ **South East Europe:** Tarkett SEE – Tel. +381 21 7557 649 (44) 569 12 21 ■ **Ukraine:** Tarkett UA – Tel: +38 (0) 44 35 45 621 ■ **ASIA AND OCEANIA:** **Australia:** Tarkett Australia Pty Ltd – Tel. +61 2 88 53 12 00 ■ **China:** Tarkett Floor Covering (Shanghai) Co. Ltd. – Tel. +86 (21) 60 95 68 38 ext 841 ■ **North East Asia:** Tarkett Hong Kong Limited – Tel. +852 2511 8716 ■ **India:** Tarkett Flooring India Pvt. Ltd. – Bangalore – Tel. +91 80 4130 3793 – New Delhi – Tel. +91 11 4352 4073 – Mumbai – Tel. +91 22 2648 8750 ■ **South East Asia:** Tarkett Flooring Singapore Pte. Ltd. – Tel: +65 6346 1585 ■ **AFRICA:** **Tarkett International:** Tel. +33 1 41 20 41 01 ■ **MIDDLE EAST:** **Tarkett Middle East:** Tel. +961 1 51 3363/4 ■ **Israel:** Tarkett International: Tel. +33 1 41 20 41 01 ■ **NORTH AMERICA:** **USA:** Tarkett Inc. – Tel. +1 713 869 5811 / Johnsonite – Tel. +1 440 543 8916 ■ **Canada:** Tarkett Inc. – Tel. +1 450 293 173 ■ **LATIN AMERICA:** **Brazil:** Tarkett Brasil: Tel. 55 12 3954 7108 ■ **Argentina - Chile - Uruguay:** Tarkett Mercosur - Tel. +54 11 47 08 07 72 / +54 9 11 44 46 88 82 ■ **Bolivia - Colombia - Ecuador - Panama - Paraguay - Peru - Trinidad and Tobago - Venezuela:** Tarkett Latam - Tel. +55 11 9 8410 9310 / +55 11 95494 0069 ■ **Mexico / Central America:** Tarkett Mexico - Tel. +55 11 98410 9310

Due to evolution of standards, characteristics indicated in the text and images in this document are not binding only after confirmation by our departments.

Design: Agence Gecko

Printing: Xxxxxxxx

Photos copyrights: Getty images

 **Tarkett**